

LABA7 Spring Rate Dyno User Manual

Table of Contents

- 1. Introduction..... 3
- 2. Safety Information..... 4
- 3. Highlights..... 5
- 4. Standard package for Spring Dyno DAILY includes..... 6
- 5. Technical Specifications..... 6
- 6. Know Your Spring Rate Dyno..... 7
 - 6.1. Overview..... 7
 - 6.2. Toggle Switch Control..... 8
 - 6.3. Emergency Stop Button Control..... 8
- 7. Accessories..... 9
 - 7.1. Adapters..... 9
 - 7.2. Adapter Installation..... 11
- 8. First Launch..... 12
- 9. Software Setup..... 13
 - 9.1. System requirements..... 13
 - 9.2. Installation..... 13
 - 9.3. Configuration..... 14
 - 9.4. Wireless Communication..... 16
 - 9.5. USB Communication..... 18
- 10. Software Operation..... 20
 - 10.1. Main Menu Panel..... 20
 - 10.2. New Project Panel..... 21
 - 10.3. Open Project Panel..... 24
 - 10.4. Settings Panel..... 25
- 11. Troubleshooting..... 26
 - 11.1. General..... 26
 - 11.2. WiFi Configuration..... 27
 - 11.3. WiFi Operation..... 27
 - 11.4. USB Configuration..... 28
 - 11.5. USB Operation..... 28
 - 11.6. Mechanical Failures..... 28
 - 11.7. LED Light Indicator..... 29
- 12. Maintenance..... 30
- 13. Additional information..... 32
- 14. Warranty Information..... 33
- 15. Contact..... 34
- 16. EU Declaration of Conformity..... 35

1. Introduction

Dear Customer,

Thank you for purchasing this product.

To ensure this condition and safe operation, you must observe these operating instructions!

Read the entire operating instructions before using the machine for the first time. Observe all operating and safety instructions!

All company names and product names are trademarks of their respective owners. All rights reserved.

UAB LABA7

Address: Giluzio st. 15 Vilnius LT-06253 Lithuania

Email: info@laba7.com

Mobile phone: +37065715336

2. Safety Information

- Make sure to read and understand the whole user manual before using the Spring Rate Dyno (further – device).
- The device works under excessive force, therefore wear protective eye-wear and take all cautions required to work a safe environment.
- Connect the Spring Rate Dyno to a grounded power socket.
- Only use the electric cord provided with the device.
- Do not use the power cord if it is pinched, sheared, or cut.
- Do not use any power adapters if the plug **does not** fit your wall socket.
- Do not use an extension cord.
- The power socket to which you are connecting the Spring Rate Dyno needs to be easily accessible **so it could be quickly unplugged in case of emergency.**
- Do not operate near an open flame or heat source.
- Place on a flat and level surface.
- Do not place in a highly corrosive or humid environment.
- Do not use the device or any of its components if they have been damaged.
- Do not perform any maintenance while the device is plugged into the mains.
- Make sure that the safety doors are properly closed before running a test.
- Do not open or tamper with the safety lid or any other parts of the machinery during live operation.
- Make sure the spring or fork is properly loaded into the device before operation. Use an insert tube to prevent bending. Make sure the spring is centered.
- Make sure to hold the load cell in place and not over-tighten it when switching adapters due to potential damage that may be inflicted on the engine.

3. Highlights

Congratulations on your purchase of the LABA7 Spring Rate Dyno!

- Our fully automatic spring tester allows you to test the spring rate of any shock absorber spring, fork spring, air spring, bump stop or gas pressure. It does not matter which discipline you are working with – MTB, Motorcycles, Cars, 4X4, ATVs – all springs can be tested. This machine is easy to use and you can get the most accurate results immediately on your complimentary software/monitoring app.
- Spring rate testing – Check if you have the **correct** spring for the right weight or performance. **Additionally**, you can test whether the same spring rate **remains** kept throughout the travel. The device can also be used to compare two different springs.
- Test your air forks – As the market adopts air springs, our Dyno embodies the right tool to check them and make the necessary modifications.
- Test bump stops – Check the spring rate of your bump stops and make sure they are not too stiff or too plush for the rider & shock absorber combination.
- Parts tested – Shock springs/Fork springs/Air springs/Bump stops/Seal drag/Gas pressure.
- High-accuracy force/pressure sensors.

4. Standard package for Spring Dyno DAILY includes

- Spring Dyno DAILY automatic spring rate tester unit.
- Spring safety rod.
- Power cable(EU or USA plug variant).
- USB Communication cable for connection to PC.
- Standard spring installation plates.
- User manual.
- Software (free download from our webpage).
- Customer support via email / WhatsApp.

5. Technical Specifications

- Maximum stroke: 300 mm.
- Free rear spring length: 374 mm (customizable).
- Free front spring length: 564 mm (customizable).
- Speed: 5-6 mm/s.
- Maximum test force: 10000N.
- Dimensions: 642×600×1904 mm.
- Weight: 140kg.
- Voltage: 220V (110V available on request).

6. Know Your Spring Rate Dyno

6.1. Overview

The overview of the LABA7 Spring Rate Dyno is presented in the image below:

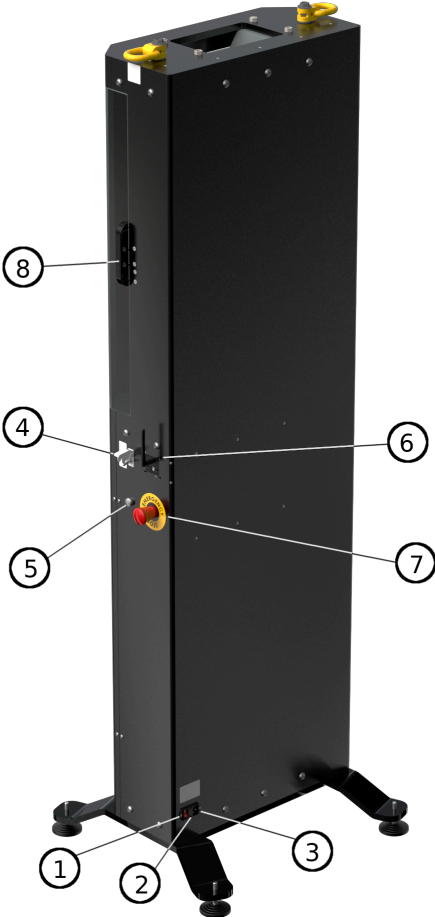

Figure 1



Figure 2

- 1. Power switch.
- 2. Fuse.
- 3. Power cable connector.
- 4. Toggle switch.
- 5. LED Indicator.
- 6. Communication port.
- 7. Emergency stop button.
- 8. Cover handle.
- 9. Adjustable legs.
- 10. Safety cover.
- 11. Mounting adapters.
- 12. Shipping anchors.

6.2. Toggle Switch Control

Use the toggle switch to adjust the preload when mounting springs. Use the switch to remove any empty space between the bottom and top end of the spring before running a test to minimize inaccurate readings during the initial test run. When using the “**Automatic**” mode, the switch is automated based on the preload threshold that is set for the test.

1. Flicking the switch up will result in the Spring Dyno pushing the spring into the upper mount.
2. Flicking the switch down will result in the Spring Dyno releasing the spring by moving the platform downwards.

6.3. Emergency Stop Button Control

The Emergency Stop button can be activated anytime during operation. To activate the emergency button:

1. Press the button to stop any operation.
2. Rotate the Emergency Stop button to the right to release it and deactivate the emergency state.
 - a) If the Emergency Stop button was engaged during a test, the emergency state will stay even after releasing the button. In order to deactivate the emergency state, restart the Spring Dyno or go to the application and Reset Emergency State from New Project screen (more details in Section 9.2).



ATTENTION: Use the emergency stop button to engage the safety mechanism before opening the protective lid, or removing springs to disable the Dyno from running by accident and prevent the risk of injury.

7. Accessories

7.1. Adapters

Here you will find various adapters compatible with the Spring Dyno.

1. Spring Dyno Motorcycle fork adapter. Custom inserts upon request and standard axle used for mounting.



Figure 3

2. Spring Dyno Bicycle fork adapter with sliding adapter and adjustable offset.



Figure 4

3. Self-preload clevis for shocks with gas expansion tank.



Figure 5

4. Standard U-shape clamps for shocks.



Figure 6



ATTENTION: Make sure to hold the load cell in place and not over-tighten it when switching adapters, due to potential damage that may be inflicted on the engine.

7.2. Adapter Installation

Whenever installing a new adapter into the Dyno or replacing an existing one, follow the steps below:

- When replacing a top adapter, follow the instructions for that adapter installation.
- When replacing a bottom adapter, it is important to hold the load cell in place (Figure 7 – Step 1).
- Use a wrench to keep the load cell in place, and then unscrew the adapter (Figure 7 – Step 2).

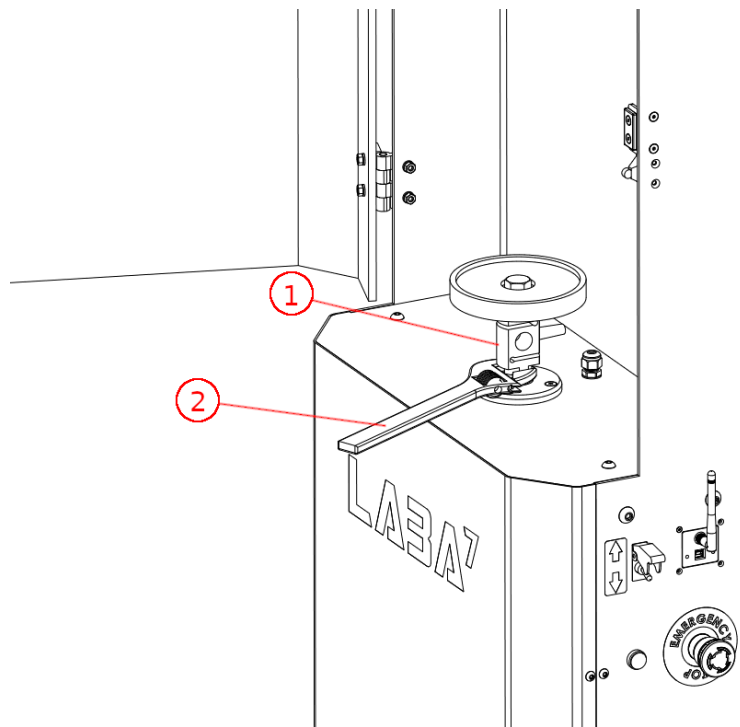

Figure 7

8. First Launch

Follow the steps below to launch the Spring Rate Dyno for the first time:

1. Plug the power cable provided with the device into the power connector and plug it into the mains.
2. Connect the WiFi antenna.
3. Turn the Spring Rate Dyno power switch on. The green light on the switch will light up.
4. Open the safety lid (Figure 8 – Step 2) by pulling from the cover side handle.

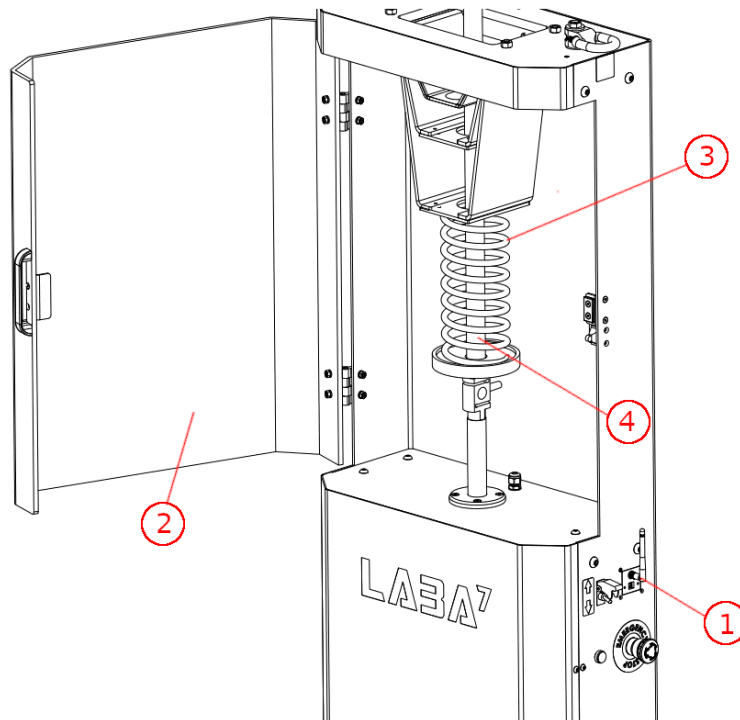

Figure 8

5. Press the red stop button to disengage the Spring Dyno before mounting the springs.
6. Place the spring (Figure 8 – Step 3) on the mounting platform in a vertical manner.
7. Place the insert tube inside the spring to prevent it from bending or falling out during a test (Figure 8 – Step 4).
8. Use the preload switch to adjust the spring to tighten the fitting and secure the spring to prevent any free movement.
9. Release the red stop button and close the lid to begin testing.
10. Power off the Spring Rate Dyno to configure the software.

9. Software Setup

9.1. System requirements

These are the minimum requirements for the application to function in conjunction with the Dyno:

- Windows 7 (SP1), 8, 10, 11
- NET Framework 4.7.2
- 4 GB of RAM
- 1 GB of free disk space

9.2. Installation

Contact LABA7 support to receive the latest Spring Rate Dyno software version.

1. Open the Spring Rate Dyno software folder.
2. Locate the "Setup.exe" executable file and double-click to run the installation.
3. Once the setup panel has launched, click "Install" to continue.
4. Setup will install the program and automatically launch the software once the installation is done (a shortcut will be created on your desktop).

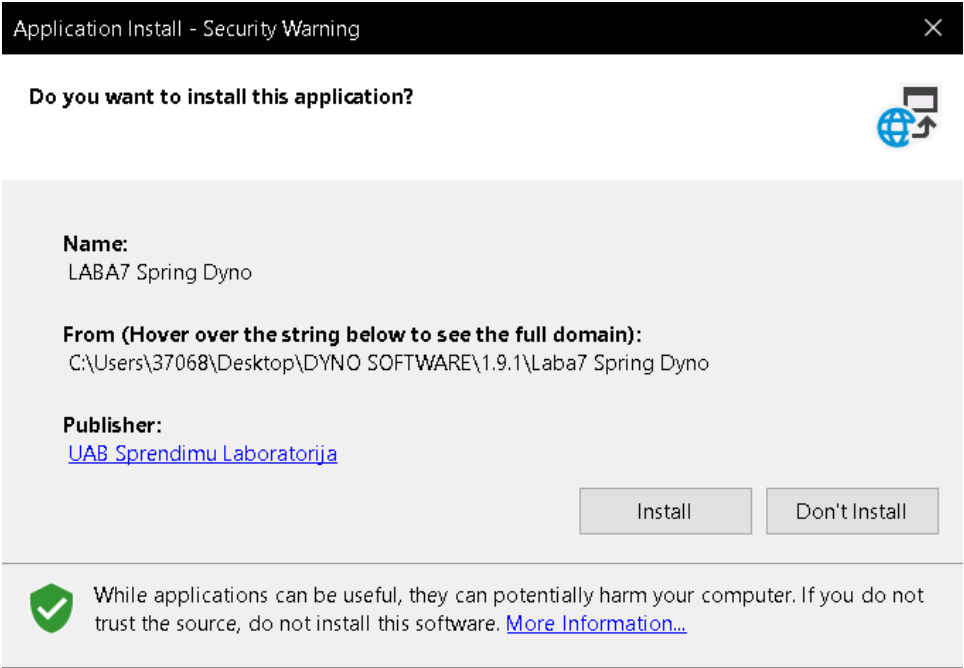

Figure 9

9.3. Configuration

After launching the application for the first time, follow the steps below to configure the initial settings:

1. Launch the application and go to the **Settings** page.
2. In the **General Settings** tab, select the **Default Data Catalog** by clicking on the **Select** button (Figure 10 – Step 1). This catalog will be used to store test data files.

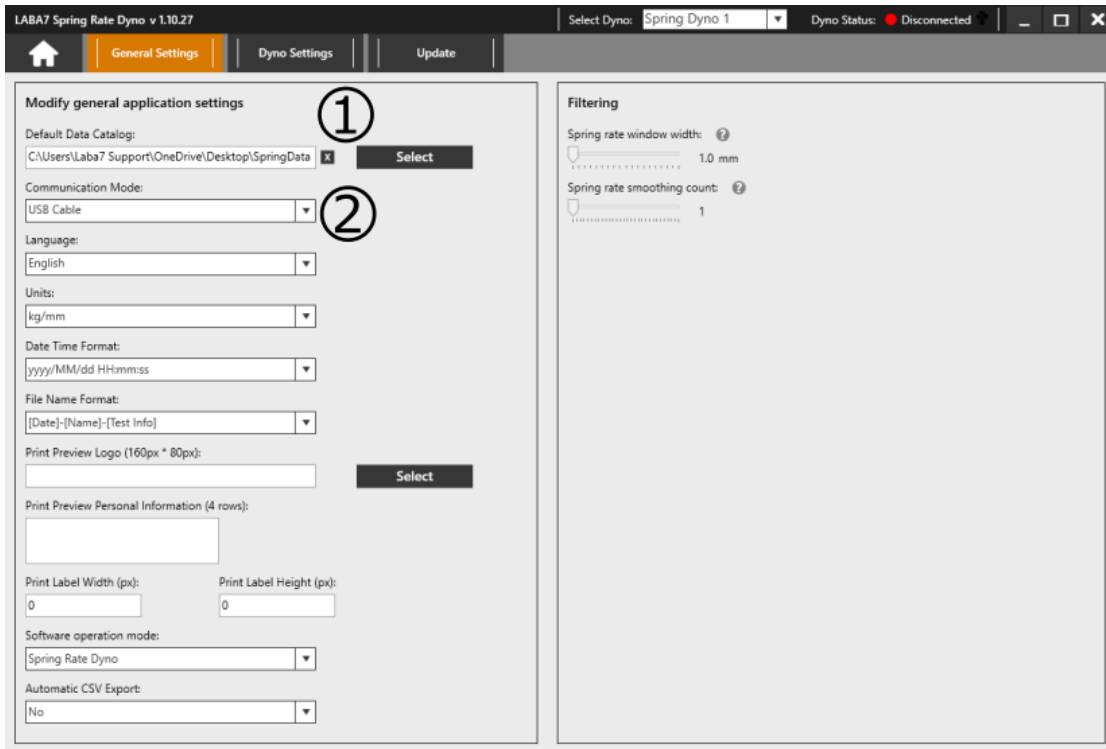

Figure 10

3. Select **Communication Mode** by clicking on the drop-down menu (Figure 10 – Step 2):
 1. Wireless communication—WiFi network is required in the workshop (no LAN connection is needed). Make sure the router is relatively close to the Dyno and there are no obstacles to cause interference to the signal.
 2. USB cable—the cable will have to be connected at all times during operation with the Dyno.
4. Go to the **Dyno Settings** tab.

5. Add a new Dyno model by clicking the **Add** button (Figure 11 – Step 1).
 - You can rename the model by double-clicking on the model's name in the Dyno list.
 - Multiple models are used for a quick switch between them during the operation.

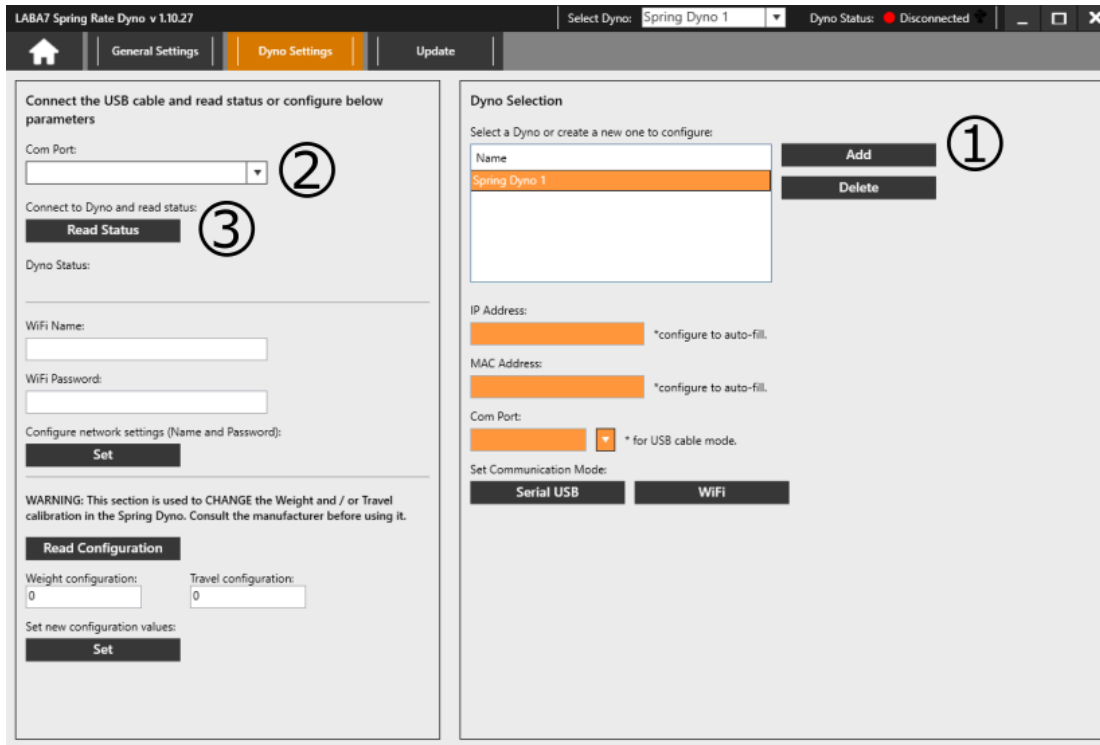

Figure 11

6. If the Dyno is powered off, turn it on.
7. Connect the USB cable to the LABA7 Dyno and to the computer.
8. Wait 15-20 seconds for the Dyno to initialize.
9. Select the newly appeared Com Port of the connected Dyno from the drop-down menu (Figure 11 – Step 2).
10. Click on the **Read Status** button (Figure 11 – Step 3).
11. One of the following statuses will appear:
 - Serial communication enabled — Dyno is configured for the USB communication mode.
 - WiFi settings are not set up — Dyno is configured for the wireless communication mode, but the settings of the local wireless network are not.



ATTENTION: Regarding your preferences, go to the next section for either wireless or USB communication setup.

9.4. Wireless Communication

This section indicates how to set up wireless communication between the Dyno and the computer. The following items should be considered when choosing this communication type:

- Up-to-date Wireless Router in the workshop to ensure a stable and fast connection for data transfer during the Dyno operation.
- Open area for a Dyno to operate with a router placed in a line of sight from the Dyno. Any object in between the Dyno and the wireless router can cause a negative impact on the wireless signal resulting in poor signal quality and lost data packets.

Follow the steps below to configure the wireless communication:

1. Launch the application and go to the **Settings** page.
2. In the **General Settings** tab, select **Wireless Communication Mode** by clicking on the drop-down menu.
3. Go to the **Dyno Settings** tab.
4. If the Dyno is powered off, turn it on.
5. Connect the USB cable to the LABA7 Dyno and to the computer.
6. Wait 15-20 seconds for the Dyno to initialize.
7. Select the newly appeared Com Port of the connected Dyno from the drop-down menu.
8. Click on the **Read Status** button.
9. Note the Status that was received from the Dyno (Figure 12 – Step 1).
10. Check the Status that was received from the Dyno:
 - Connected to WiFi—Dyno is already configured for the wireless connection mode and connected to the Router; no further action is required.
 - WiFi settings are not set up—Dyno is already configured for the wireless connection mode, but the settings for connecting to the router are not set up. Skip to step 14.
 - Serial communication enabled—proceed with the next step to switch to the wireless connection mode.
11. Select the Com Port of the connected Dyno from the drop-down menu in the Dyno Selection area (Figure 12 – Step 2).
12. Click on the **WiFi** button to enable the wireless communication mode in the Dyno (Figure 12 – Step 3).
13. Enter the WiFi name and password into the corresponding fields (Figure 12 – Step 4).
14. Click on the **Set** button (Figure 12 – Step 5).
15. Wait up to 1 minute for the application status to refresh.

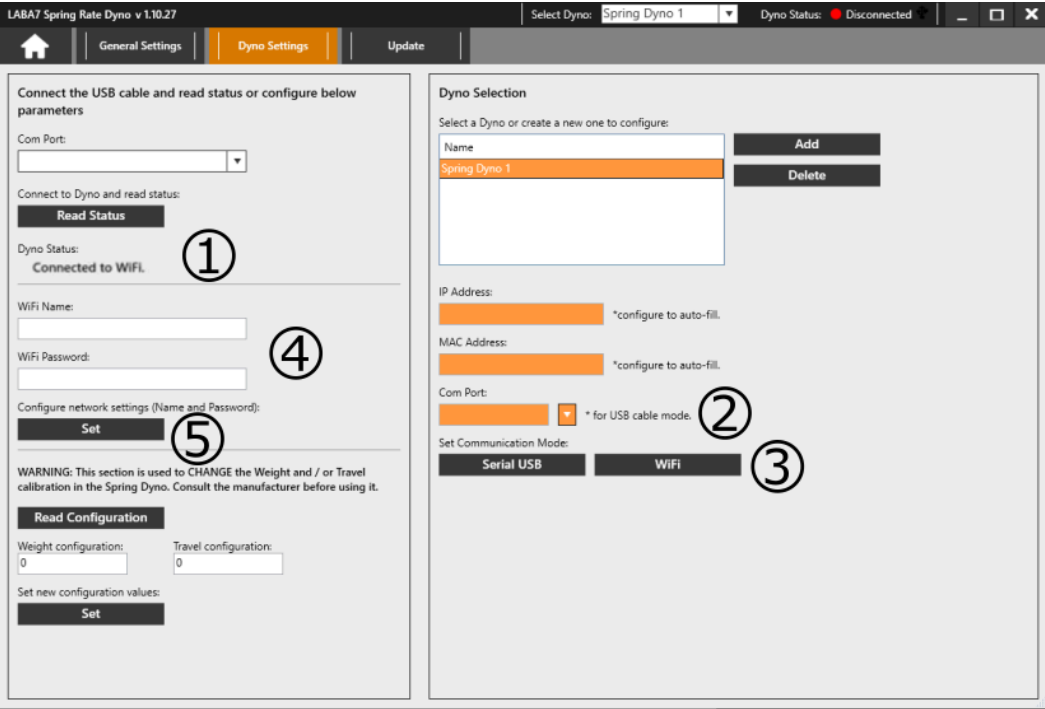

Figure 12

After a successful connection to the router, Dyno status should indicate connected to WIFI with a green indicator in the upper right application corner.



ATTENTION: If any steps fail or the Dyno is still not connected to the application, go to the troubleshooting section.

9.5. USB Communication

This section indicates how to set up the USB communication between the Dyno and a computer.

Follow the steps below to configure the USB communication:

1. Launch the application and go to the **Settings** page.
2. In the **General Settings** tab, select the **USB Communication Mode** by clicking on the drop-down menu.
3. Go to the **Dyno Settings** tab.
4. If the Dyno is powered off, turn it on.
5. Connect the USB cable to the LABA7 Dyno and to the computer.
6. Wait 15-20 seconds for the Dyno to initialize.
7. Select the newly appeared Com Port of the connected Dyno from the drop-down menu.
8. Click on the **Read Status** button.
9. Note the Status that was received from the Dyno (Figure 13 – Step 1).
10. Check the Status that was received from the Dyno:
 - Connected to WiFi—Dyno is configured for the wireless connection mode and connected to the Router. Proceed with the next step to switch to a USB connection.
 - WiFi settings are not set up—Dyno is configured for the wireless connection mode but the settings for connecting to the router are not set up. Proceed to switch to a USB connection.
 - Serial communication enabled—skip to step 14.
11. Select the Com Port of the connected Dyno from the drop-down menu in the Dyno Selection area (Figure 13 – Step 2).
12. Click on the **Serial USB** button to enable the USB communication mode in the Dyno (Figure 13 – Step 3).

13. Wait up to 1 minute for the application status to refresh.

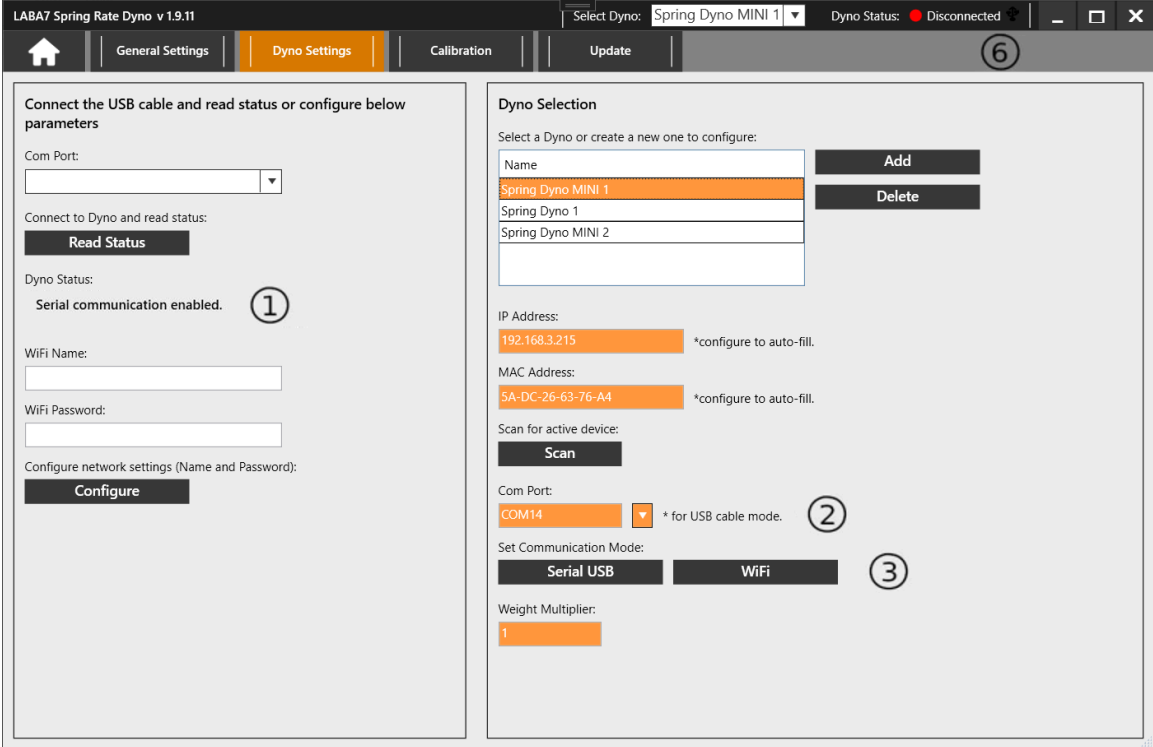

Figure 13



ATTENTION: If any steps fail or the Dyno is still not connected to the application, go to the troubleshooting section.

10. Software Operation

10.1. Main Menu Panel

Once the application has been launched, you will be greeted with three options from the main menu:

- New project – create and manage new spring tests.
- Open – import existing projects and compare different tests.
- Settings – options panel containing general settings and a configuration menu for managing Dyno connectivity.

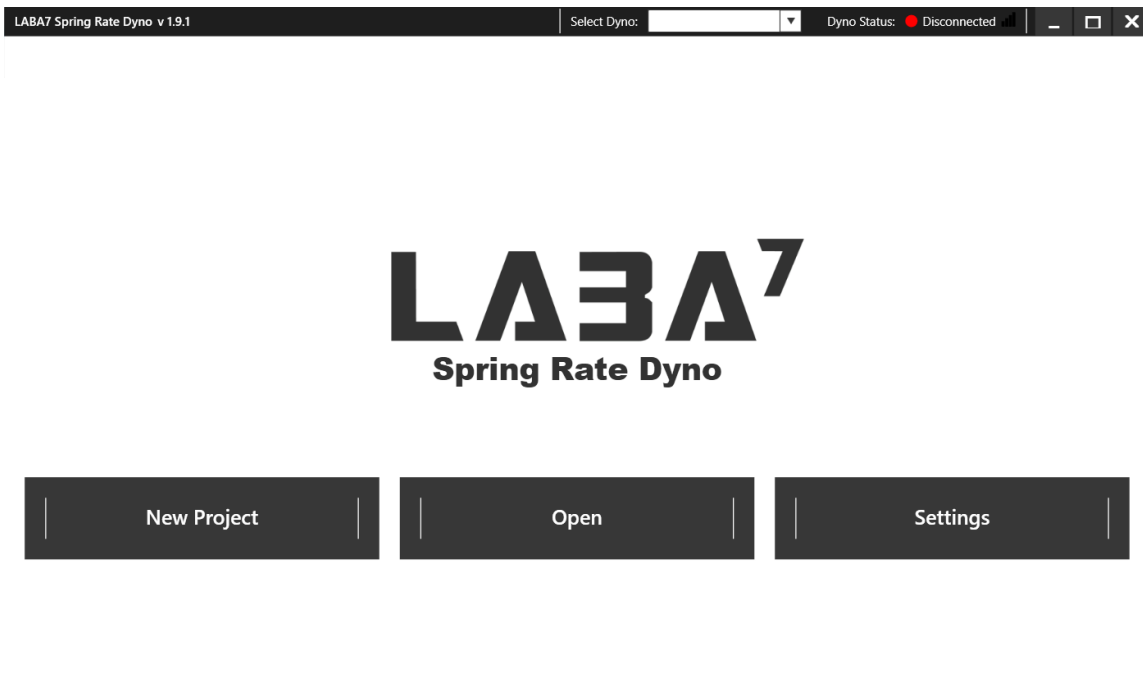

Figure 14

Additionally, you can check your software version and select a configured Dyno from the drop-down menu, as well as monitor your Dyno connectivity at the top menu from any window in the application.

10.2. New Project Panel

This panel allows you to conduct spring testing and set up preferred parameters for new spring tests. Below you will find descriptions of each parameter available to modify on the test panel:

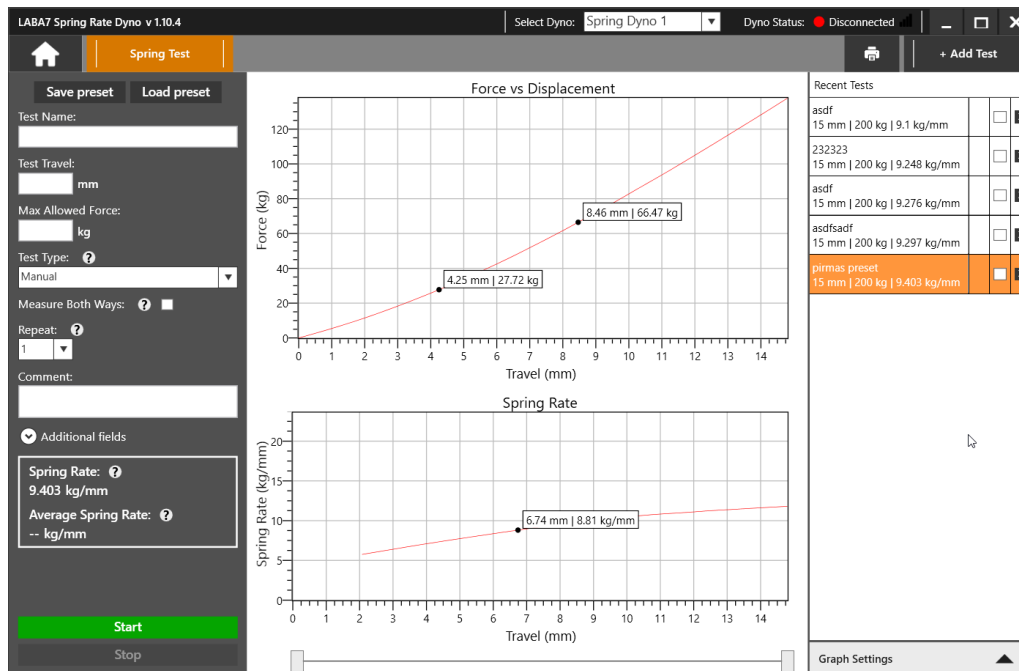

Figure 15

- Test Name – the title of your project.
- Test Travel – preferred travel length for the spring during a test run.
- Max Allowed Force – hard cap threshold input of the maximum allowed force to be applied during an ongoing test.
- Test type – allows the switching between three different test types:
 - Manual – configure spring parameters manually for testing.
 - Automatic – set a custom threshold for the test to start only when it meets the preload requirements.
 - Stretch (Reverse) – switches test to the stretching mode.
- Measure both ways – the force will be measured during compression and decompression of the spring.
- Preload force – sets the force threshold at which measurement begins.
- Repeat – custom number of times a test can be repeated.
- Comment – allows input of comments/work notes.
- Additional fields – allows to enter some additional data about the spring being tested, such as: manufacturer, model, spring type, part number, revision, batch number.

The following additional features are available in the panel:

- + Add Test – add an additional test to the recent tests panel.
- Marking points – mark specific points within the graph to highlight results. (Left click to add point & right-click to remove).
- Print preview – add comments and preview print page. Contains test details (travel/force/comments) and print data (print date, logo, and test name).
- Zoom in and out – use the mouse scroll wheel to zoom in or zoom out the displayed graphs. Double-clicking the left mouse button on the graph area will restore the default zoom. It is possible to scroll only on one axis by using the scroll wheel directly over the horizontal or vertical axis label.
- Recent Tests – highlight/check-mark & change color schemes to differentiate results.

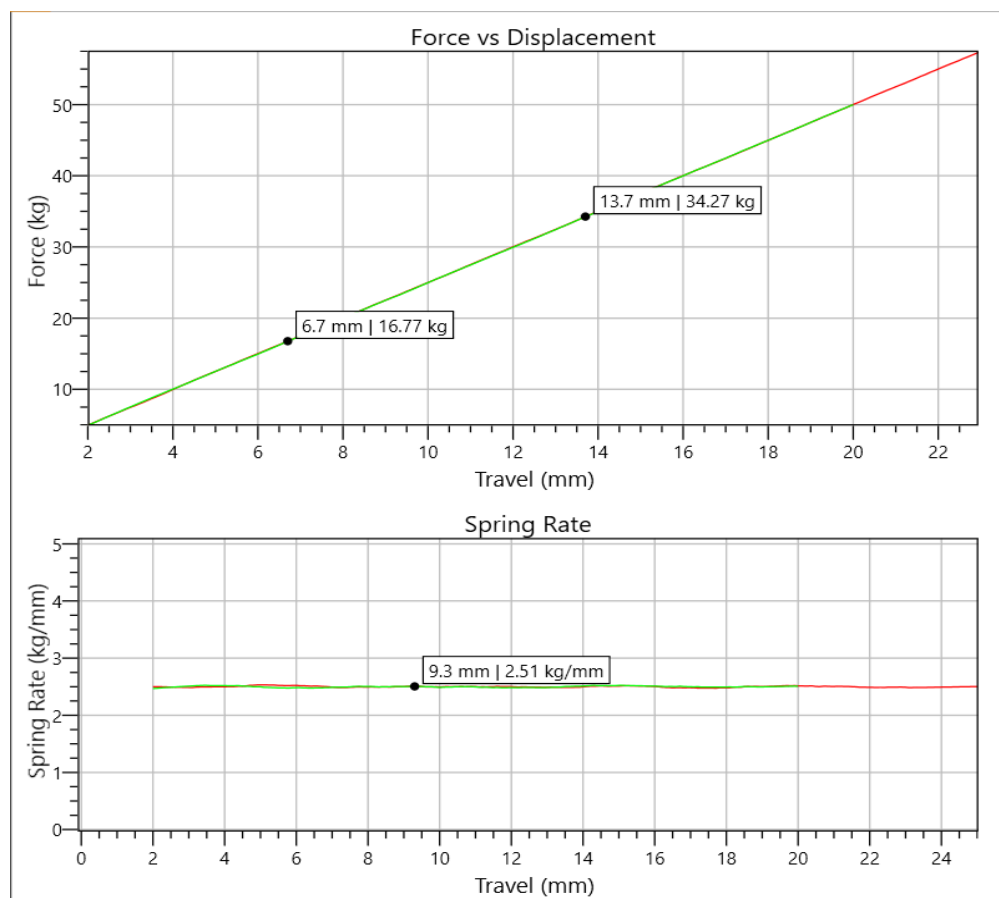

Figure 16

- Force vs Displacement – X-axis calculates the travel length (by default measured in mm). Y-axis represents the force (measured in kg by default).
- Spring rate – X-axis calculates the travel length (by default measured in mm). Y-axis represents the spring rate (measured in kg/mm by default).

- Graph slider – adjust the left and right (1,2) slider points below to calculate the spring rate within a specific point of the chart.

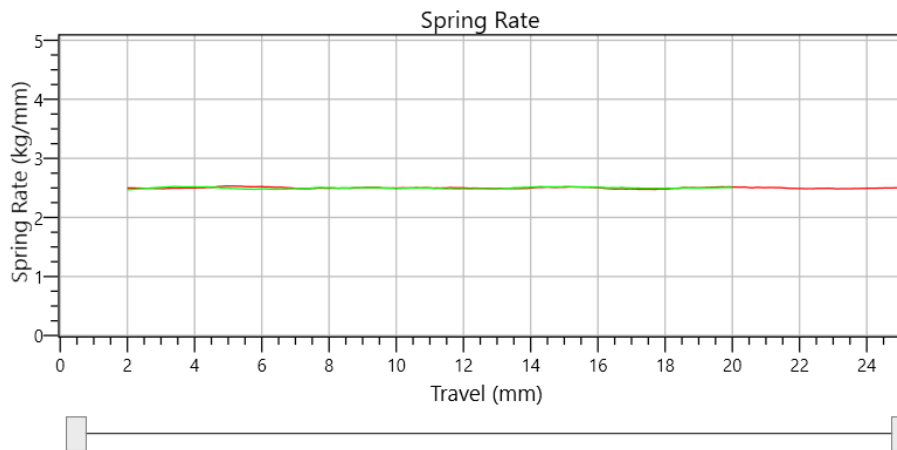

Figure 17

- Save preset – saves the preset using the data entered in the test name, test travel, max allowed force, test type and additional info fields.
- Load preset – loads the previously made preset.



ATTENTION: Sliders affect just the spring rate, not the average spring rate.

Following options are available in the **Graph Settings** expandable panel on the bottom-right side of the screen:

- Zero Tare – the feature sets the zero tare of the device. It is used to calibrate the zero weight after changing the adapter on the load cell or after placing a spring or a fork onto the plate/clamp in the device to properly measure the preload force.
- Shift to 0 – shifts the Force vs Travel graph to start from 0 kg force. If an option to not shift is selected, the graph will display the actual force that is measured by the device.
- Reset Emergency State – if during a test an Emergency Button was engaged, the Dyno will enter an Emergency State. The Reset button deactivates the emergency state.

10.3. Open Project Panel

Review or compare different tests, as well as use it to export/import and print out your work.

- Left side displays test parameters and spring rates.
- Right side allows you to highlight/check-mark and differentiate tests for ease of use and convenient monitoring.
 - Clicking on the checkbox allows you to compare those selected tests.
- + Add test – add more tests to the **Recent Tests** window.
- Export – export highlighted test to your preferred location within your device.
- Print Preview – prepare the highlighted tests for printing.
- - Clear All – clears all tests from the **Recent Tests** menu.

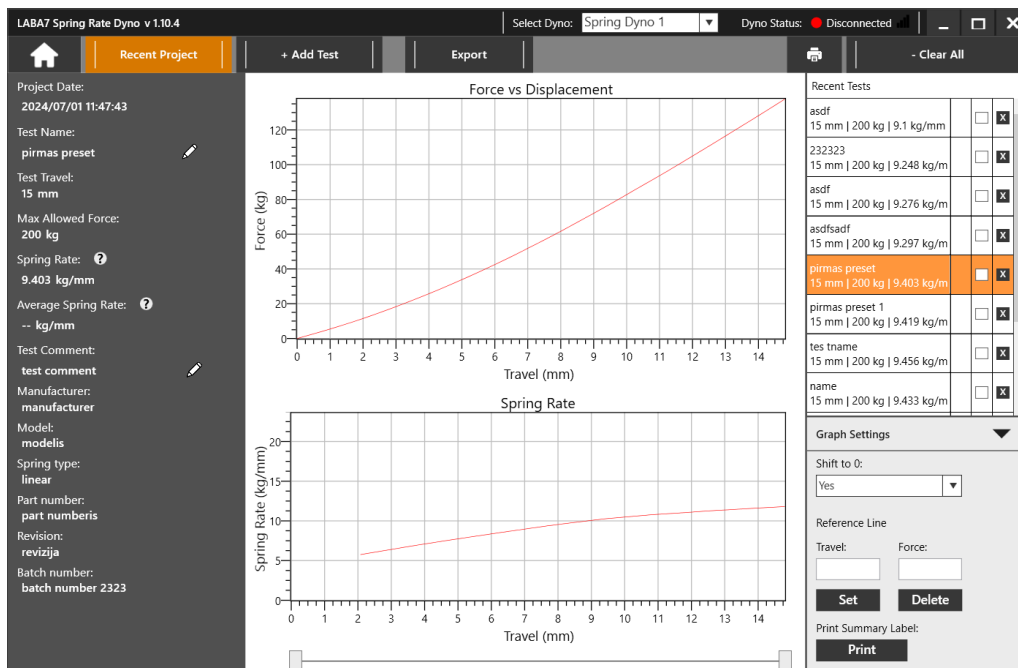

Figure 18

Following options are available in the **Graph Settings** expandable panel on the bottom-right side of the screen:

- Legend visibility – add or remove visible legend to the graph.
- Reference line – add reference travel & force details to the graph.
- Print label – add the print summary label for a printout which is used when you have a label printer (label height and width is configured in the Settings).
- Shift to 0 – shifts the Force vs Travel graph to start from 0 kg force. If an option to not shift is selected, the graph will display the actual force that is measured by the device.

10.4. Settings Panel

Here you will find general parameters available to change, as well as the Dyno configuration tab.

- Click the “Settings” button. General settings window will appear.

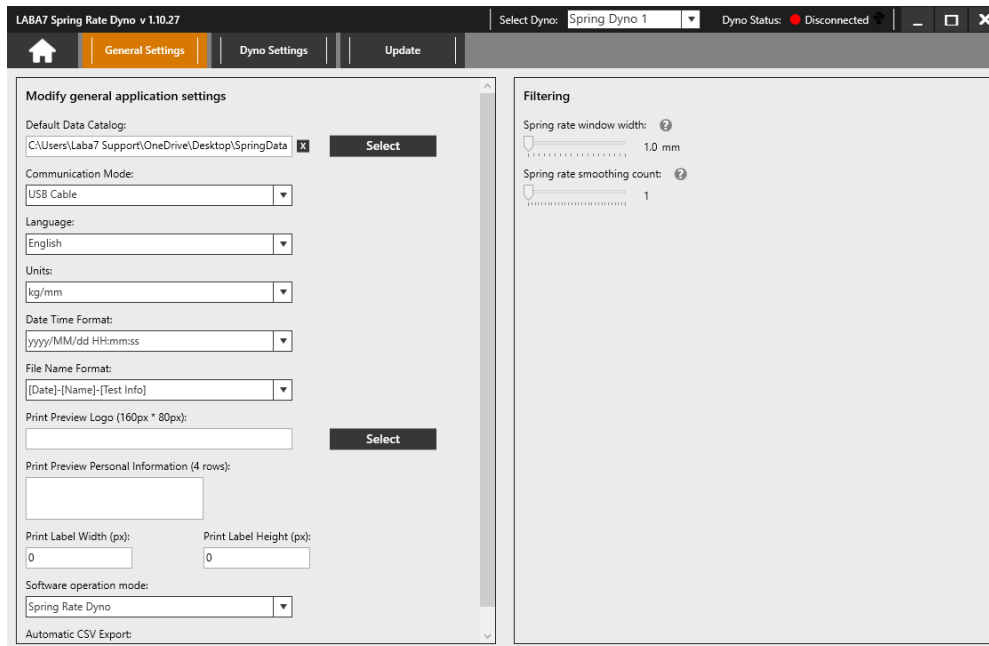

Figure 19

- Default Data Catalog
 - Press the “Select” button to configure “Default Data Catalog”.
 - Within explorer, pick a location where you want to store the catalog.
 - Pick or create a new folder and highlight it. Press “Select Folder” at the bottom to set the catalog.
- Communication Mode – set communication mode (WIFI/USB).
- Language – set preferred language (make sure to restart app for changes to take effect)
- Units – set measurement units for preferred monitoring (kg/N/lbs).
- Date Time format – allows to select the desired date and time format.
- File Name format – allows to select desired file name format.
- Print Preview Logo – add a logo to be used for label summary printing and general test print (recommended logo size is 160×80 px).
 - Press “Select” button to configure “Print Preview Logo” and select your Logo:
 - Within explorer, locate your custom logo.
 - Highlight the logo image file and select “Open” to set the print preview.
- Print Preview Personal Data Visibility – add print comments.
- Print Label size – set the label printer width and height.
- Software Operation Mode – allows selection of the software operation mode used by the device. The available modes are **Spring Rate Dyno** and **Damper Preload Dyno**.

- Automatic CSV Export – automatically saves measurement data in CSV format after a test is completed.
- Spring Rate Window Width – defines the travel range around each measurement point used for spring rate estimation. Increasing the window width improves curve smoothness and stability, while decreasing it increases sensitivity to local variations but may introduce additional noise.
- Spring Rate Smoothing Count – specifies the number of adjacent spring rate points averaged after the initial calculation. Increasing the smoothing count reduces small fluctuations in the stiffness curve, producing a more stable and visually consistent result. Excessive smoothing may obscure rapid changes in spring behavior. Setting the value to 1 disables this post-processing averaging.



ATTENTION: To properly change the Communication Mode go to the Software Setup section.

11. Troubleshooting

This section defines the most common issues that can arise when using the Dyno related to communications, data transfer, application, or mechanical issues, and what steps to take to fix them.

11.1. General

Issue	Solution
Dyno is not responding, unable to communicate.	Both, the Dyno and the application, might be stuck on a loop or a cache of either one can be full. Restart the Dyno (powering it off and unplugging the USB cable for 1 minute) and restart the application on a computer.
Application is frozen or stuck on a Please Wait dialog and cannot be closed.	Close the application through the Task Manager . If the application is stuck on a USB connection, unplug the USB cable as well to properly shut down the application.
Cannot communicate with Dyno over a USB, Com Port does not appear in the selection.	Reconnect the USB cable (check the sockets on both ends – computer and the Dyno). If the issue persists, try a different USB cable as the latter might be damaged.

11.2. WiFi Configuration

Issue	Solution
Cannot configure WiFi parameters.	Communication mode in the Dyno is incorrect. Change the communication mode.
Cannot change the communication mode.	Com port number might be incorrect. Select the correct com port number and try again.
Cannot connect to router.	Router might not allow new connections, check the router settings or restart it.
	Check for typos, if caps lock is enabled, re-enter credentials.
Dyno is connected, but status appears to be offline.	Computer is not connected to the same network as the Dyno. Reconnect device to the same network or reconfigure the Dyno.

11.3. WiFi Operation

Issue	Solution
Test fails after starting it.	Router cache might be full resulting in a reduced bandwidth. Restart the router.
	Dyno might be receiving a weak signal. Make sure the Dyno is in an open area and the router is in line of sight of the Dyno.
Test completes, but the data is missing packets, straight lines are visible across the graph or bad graph data is presented.	The signal is unstable, or the router/application cache is full. Restart the application, router, and/or Dyno.
Unable to start a test, Dyno appears offline.	WiFi signal is bad due to disconnected WiFi antenna. Connect the WiFi antenna.
Unable to start a test, Dyno appears offline.	The IP address that is assigned to the Dyno by a router might have changed. Connect the USB cable, go to the Settings , select the proper Com Port and click on Read Status button. If the Dyno is connected to the Router, the application will update the IP address.

11.4. USB Configuration

Issue	Solution
Cannot change the communication mode.	Com port number might be incorrect. Select the proper com port number and try again.

11.5. USB Operation

Issue	Solution
Test fails after starting it, lost data packets appear in the graph.	The Windows USB driver is busy and can not receive all the data coming from the Dyno. Close all unwanted programs on the computer, check if Windows updates are not running, or if an Antivirus is not making a scan, and try again.
Unable to start a test, Dyno appears offline.	Com port number for the Dyno assigned by Windows might have changed. Go to settings and select the proper com port number in the Dyno select on area.
Test completes, but the data is missing packets, straight lines are visible across the graph or bad graph data is shown.	The signal is unstable, or the router/application cache is full. Restart the application, router, and/or Dyno.

11.6. Mechanical Failures

Issue	Solution
Dyno will not operate when attempting to start a test.	Make sure the red stop buttons are released prior to starting the tests.
Spring keeps shifting/does not hold in place when running compression.	Make sure to insert the mounting tube into the spring and then secure it within the dyno to hold it in place.
Dyno will not power on/communicate with the software	Check if the power grid cable is compatible with the socket.
The device power switch does not light up, and the device does not start.	Unplug the power cable and change the fuse near the power switch. Fuse parameters: 5×20/10A.

11.7. LED Light Indicator

Light Color	Meaning
Orange	Dyno is starting up after power on. Please wait.
White	Configuration is incomplete or WiFi network is not available. Follow the Software Setup section.
Red	The Emergency Stop button is engaged or the doors are open.
Blue	Dyno is connecting to the wireless network. Please wait.
Yellow	Dyno is ready for the operation.
Green	Operation in progress. Please wait until the operation completes.



ATTENTION: In case the issues persist, contact Laba7 support team for help.

12. Maintenance

This procedure describes how to:

- Verify the load cell accuracy of the Spring Dyno.
- Recalibrate the unit if measurement deviation is detected.

This maintenance should be performed periodically or whenever measurement accuracy is in question.

Calibration Verification

1. Ensure the Spring Dyno is completely empty (no load applied) and is connected to computer with a USB cable.
2. Open the Spring Dyno software.
3. Click **“New Project”**.
4. Click **“Live”**.
5. Click **“Tare”** to tare load cell.
6. Place a known calibration weight on the plate inside the Spring Dyno.
 - Minimum recommended weight: 5 kg.
 - A heavier known weight is recommended for improved accuracy.
 - The weight must be precisely known.
7. Compare the displayed force value, shown near **“Force”** at the top of the software, with the known weight.
 - If the displayed value matches the known weight – **Maintenance is complete. No calibration is required.**
 - If the displayed value does not match the known weight – **Proceed to Calibration Adjustment Procedure section.**

Calibration Adjustment Procedure

8. Click **“Home”** (top left corner).
9. Click **“Settings”**.
10. Select **“Dyno Settings”** tab.
11. Click **“Read Configuration”**.
12. Set **“Weight Configuration”** to: 1000
13. Leave **“Travel Configuration”** unchanged (use the value shown after pressing **“Read Configuration”**).
14. Click **“Set”**.
15. Click **“Home”**.
16. Click **“New Project”**.
17. Click **“Live”**.
18. Click **“Tare”**.
19. Place the known calibration weight (minimum 5 kg) on the plate.
20. Record the measured value shown in the software.
21. Use the following formula: $\text{Weight Configuration} = \text{Calibration Weight} \div \text{Measured Weight}$.

Example

Calibration Weight: 5 kg

Measured Weight: 4.9 kg

$$\text{New Configuration Value} = \left(\frac{\text{Calibration Weight}}{\text{Measured Weight}} \right) \times 1000$$

$$\text{New Configuration Value} = \left(\frac{5}{4.9} \right) \times 1000 = 1020.408$$

New Weight Configuration value: 1020

22. Click **“Home”**.
23. Go to **“Settings”**.
24. Select **“Dyno Settings”** tab.
25. Enter the newly calculated **“Weight Configuration”** value.
26. Leave **“Travel Configuration”** unchanged.
27. Click **“Set”**.

When a new weight configuration is set, repeat the steps from the **Calibration Verification** section.

13. Additional information

This section provides additional information related to conformity with the relevant Union harmonisation legislation:

- This equipment complies with the Radio Equipment Directive 2014/53/EU. It contains a u-blox NINA-W101 multiradio module (Wi-Fi IEEE 802.11 b/g/n and Bluetooth BR/EDR/LE). Operating frequency band: 2.4 GHz ISM (2400–2483.5 MHz). The maximum radio-frequency output power transmitted in this band does not exceed 20 dBm (EIRP), in accordance with the applicable ETSI requirements.
- The crossed-out wheeled bin symbol with a solid bar shown on this equipment indicates that it must not be disposed of as unsorted municipal waste at the end of its life. It must be collected separately and sent for recycling in accordance with applicable WEEE regulations. For information on the return, collection and recycling of this product, please contact the manufacturer or your local supplier.
- LABA7 complies with the applicable obligations of the REACH Regulation (EC) No 1907/2006. If any component of this equipment contains a substance of very high concern (SVHC) in a concentration above 0.1 % w/w, information in accordance with REACH Article 33 will be provided on request.

14. Warranty Information

LABA7 Spring Rate Dyno is covered for a 1-year of manufacturer warranty starting from the date of purchase and it covers any manufacturer-related failures during that period.

WHAT IS NOT COVERED

ALTERATION, MISUSE, OR ACCIDENT DAMAGE

Examples are:

- Failure to operate the device in accordance with the Owner's manual.
- Collision, fire, theft, freezing, vandalism, riot, explosion, or objects striking your device.
- Alteration of your device, including software programming or other components.
- Damage caused by improper maintenance or failure to follow the recommended maintenance schedule.

The repair of damages that are caused because parts or services used were not those prescribed in this manual's recommended maintenance schedule is not covered under warranty. It is the owner's responsibility to maintain the device as more fully set forth in, and in accordance with, the maintenance schedules outlined in this manual.

MODIFICATIONS

Damage or performance problems resulting from modifications to your device are not covered under warranty.

Examples of modifications:

- Altering any mechanical parts or software programming.

The manufacturer is not responsible for any damages to the device during the transportation. During accepting the shipment, please inspect the package for any visual damage. If the package is damaged, do not accept it.

15. Contact

If you have further questions about the product or need help with the installation, our technical staff will be happy to help you. Contact information can be found on our website www.laba7.com.

UAB LABA7

Address: Giluzio st. 15 Vilnius LT-06253 Lithuania

Email: info@laba7.com

Mobile phone: +37065715336

Reprinting, even in extract, is allowed only after obtaining approval. We reserve the right to make changes to the product at any time, if we consider them to be in the interest of quality improvement, without prior notice or notification. Figures may be examples, which may differ in appearance from the goods delivered. We also reserve the right to errors, and cannot be held responsible for typographical mistakes. Our general terms and conditions apply.

LABA7

EU Declaration of Conformity

Date of Issue 10th October 2020 Vilnius, Declaration Number 2020-10-10/01

Name of the manufacturer:	LTD "LABA7"
Address of the manufacturer:	Gilužio str. 15, LT-06239, Vilnius, Lithuania
Contacts of the manufacturer:	info@laba7.com
Object of the declaration:	Spring rate dyno DAILY
Identification code of the object:	SRD2-00001
Description of the object:	Fully automatic spring rate tester for shock springs, fork springs, air springs, coils, and bump stops of any size. Custom adapters can be used to test springs up to 1000 mm. Main specifications: adjustable stroke: 0–300 mm; maximum allowed force: 10 000 N; free rear spring length: 374 mm; free front spring length: 564 mm; dimensions: 642x600x1904 mm; weight: 140 kg.
Object of the declaration described above is in conformity with the relevant Union harmonisation legislation:	<ul style="list-style-type: none">– Machinery (MD) Directive 2006/42/EC– Electromagnetic Compatibility (EMC) Directive 2014/30/EU– Low voltage (LVD) Directive 2014/35/EU– Radio Equipment (RED) Directive (2014/53/EU)– Restricts hazardous substances in electrical and electronic components (RoHS) Directive 2011/65/EU
References to the relevant harmonized standards used or references to the other technical specifications in relation to which conformity is declared:	<ul style="list-style-type: none">– EN IEC 61000-6-1:2019– EN IEC 61000-6-2:2019– EN IEC 61000-6-3:2021– EN IEC 61000-6-4:2020– EN IEC 61000-3-2:2019– EN IEC 61000-3-3:2013– ETSI EN 301 489-1:2019– ETSI EN 301 489-17:2020– IEC 60335-1:2020
Additional information:	This declaration certifies compliance with the above-mentioned directives. This declaration of conformity is issued under the sole responsibility of the manufacturer. The technical documentation for the object of declaration is available from the manufacturer at the address above.
Name and title of the manufacturers' representative:	Andrius Liškus CEO
Signature of the manufacturers' representative:	