

LABA7 Car Scales

User Manual

Lithuania 2023

Contents

1.	Introduction	3
2.	Safety Information	4
3.	Highlights	5
4.	Technical Specifications	5
5.	Know Your Scales	6
5.1.	Overview	6
6.	Accessories	7
6.1.	Sliding plate	7
6.2.	Laser leveling set	7
7.	Preparation for use	8
7.1.	Assembling the scales	8
8.	First launch	8
9.	Weighing a car	10
9.1.	Measuring total weight of the car - Bubble leveling	10
9.2.	Weighing out corner weight - Laser leveling	12
9.3.	Measuring distances between wheels and axles	13
9.4.	Putting the car onto the scales	14
10.	LABA7 Scale Software	14
10.1.	Visual and text modes in the app	15
10.2.	Setup devices	16
10.3.	Car setup	16
10.4.	Navigation	17
10.5.	Tare	17
10.6.	Options	18
10.7.	Calibration	18
10.8.	Reports	19
10.9.	Calculations and measurements	20
11.	Troubleshooting	22
11.1.	Possible problems and solutions	22
11.2.	Malfunctions	23
12.	Maintenance	24
13.	Warranty information	25
14.	Contact	26

1. Introduction

Dear Customer,

Thank you for purchasing this product.

To ensure safe operation, you must observe these operating instructions!

Read the entire operating instructions before using the product for the first time. Observe all operating instructions and safety instructions!

All company names and product names are trademarks of their respective owners. All rights reserved.

This product meets the requirements of valid EU directives.

- 2014/30/EU EMC
 - EN61000-6-1,
 - EN61000-6-2,
 - EN61000-6-3,
 - EN61000-6-4
- 2014/35/EU LVD
 - IEC 60335-1

UAB LABA7
Giluzio g. 15
Vilnius
Lithuania



2. Safety Information

- Make sure to read and understand the whole user manual before using the scales.
- Do not operate nearby an open flame or heat source.
- Place on a flat and level surface.
- Do not place in a highly corrosive or humid environment.
- Do not use the device or any of its components if they have been damaged.
- Do not perform any maintenance while the device is powered on.
- Do not use leaking batteries.
- Do not exceed the technical specifications of the device.
- Use only AA type batteries, do not mix it with other types.
- Do not mix new and used batteries.
- Do not attempt to recharge non-rechargeable batteries.
- Before charging rechargeable batteries-remove it from the device.
- Remove the batteries if the device is stored unused for a longer period of time.
- Do not short the power supply terminals.
- Remove and safely dispose exhausted batteries.

3. Highlights

Congratulations on your purchase of the LABA7 Car Scales!

- Bluetooth 5.1 LE connectivity.
- iOS/Android compatible.
- Lightweight billet aluminum construction.
- 4 load sensors per pad for maximum accuracy.
- 2D or 3D visualization of the center of mass.
- 3 points of easy leveling.

4. Technical Specifications

- Power 3xAAA batteries per pad (4.5V).
- Minimum weight per pad: 1kg.
- Maximum weight per pad: 1200kg.
- Working temperature (+10°C to +30°C) *device works in wider temperature range; however, the same accuracy is not guaranteed.
- Bluetooth range: up to 100m.
- 1 pad weight: 13kg.
- General size: 400x450x65mm.
- Measuring pad size: 350x400mm (billet aluminum 20mm plate).
- Resolution: 100g.
- Accuracy: 0,015%.

5. Know Your Scales

5.1. Overview

The overview of the LABA7 Car Scales is presented in the image below:

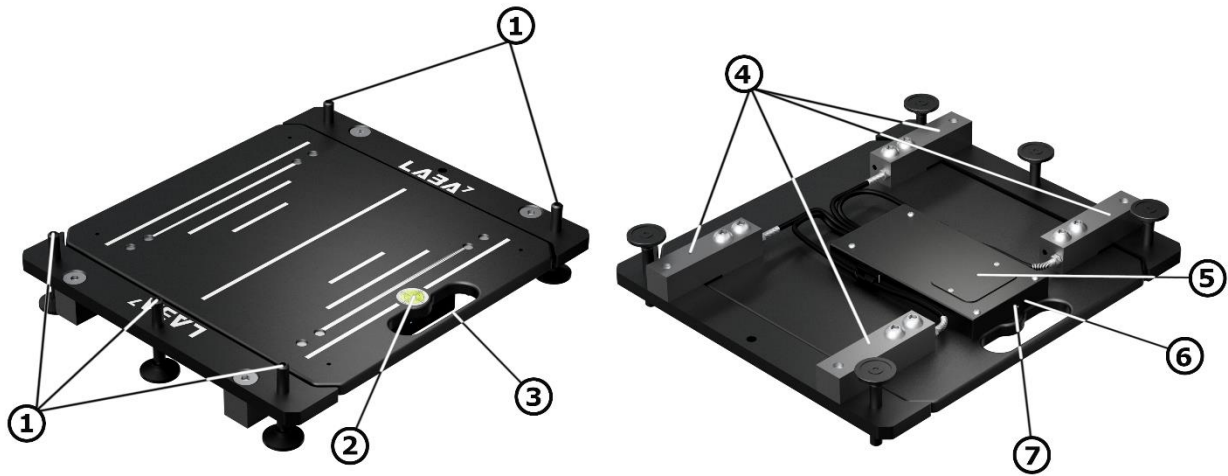

Fig. 1.

- 1.Leveling feet no. 1-4.
- 2.Leveling bubble.
- 3.Carriage handle.
- 4.Load cell no. 1-4.
- 5.Battery compartment.
- 6.Power ON button.
- 7.LED indicator.

LED indication

The scale pads have built in LED indicator, its placement is shown in the picture above (No. 7).

- Led is OFF - scale pads are in sleep mode or turned off.
- LED is blinking rapidly every 1 second - Scales in connection mode, waiting for the application to connect.
- LED pulses smoothly – scales are connected to the application, and weighing is in progress.

6. Accessories

6.1. Sliding plate

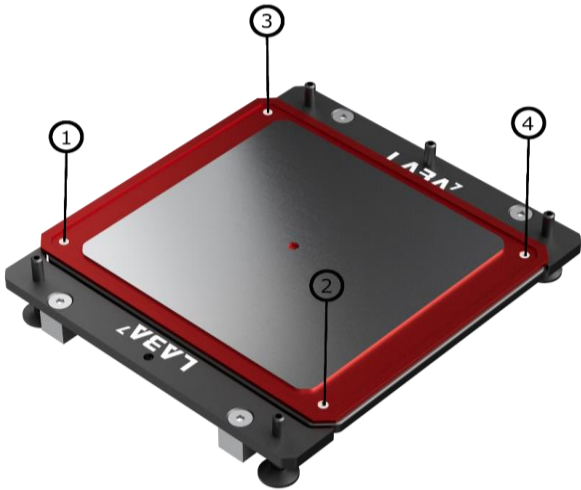

Fig. 2.

For user convenience, LABA7 offers sliding plate accessory.

Accessory is installed with 4 bolts, marked 1-4 in the picture above.

This accessory allows the wheel of the car to easily move to its position and relax the suspension of the car. This makes the process of weighing-out a car more accurate.

6.2. Laser leveling set

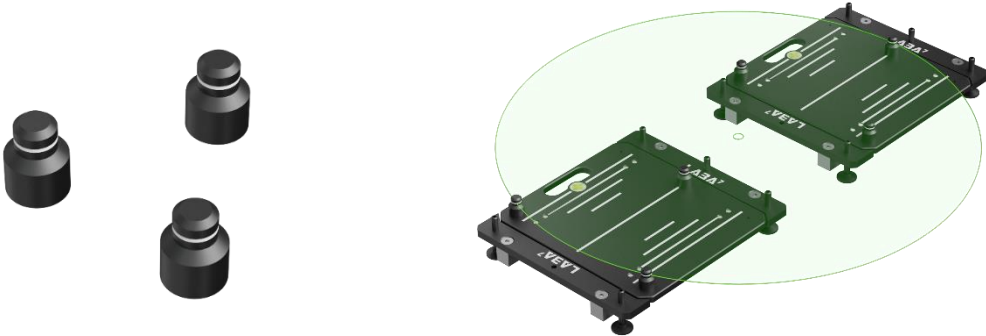

Fig. 3.

Leveling figures are used during laser leveling, which is described in paragraph 9.2.

One set includes 6 leveling figures and a laser.

7. Preparation for use

7.1. Assembling the scales

LABA7 scale pads require very little assembly after unpacking. The user only needs to install the leveling feet, which are shown in the paragraph 5 (no. 1). It has to be screwed in from the bottom side of the pad.

8. First launch

After scale pads are fully assembled, and batteries are installed, user must download the app named "LABA7 Car Scales" from the Appstore or Google play store and link every pad to the app.



ATTENTION: Bluetooth and location services must be turned on.

1. Place every pad on the ground.
2. Turn on the app.
3. Turn on all the pads with the button located near battery compartment. Blue light should blink rapidly, it means that the pad is in connection mode.

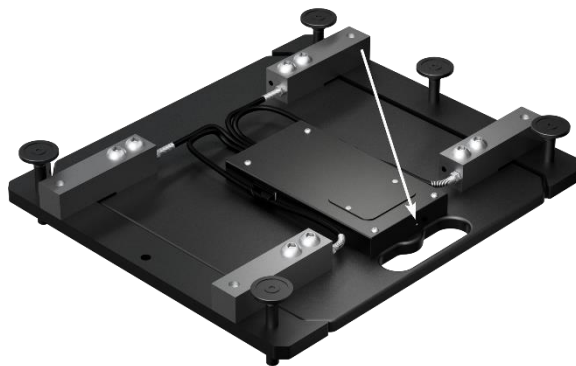



Fig. 5.

4. After scales are turned on/setup mechanically, we need to assign them in the app. Go to the settings menu by pressing  icon in the lower right corner. Then, press "setup devices"
5. Every wheel has its own pad: F-L, F-R, R-L, R-R.

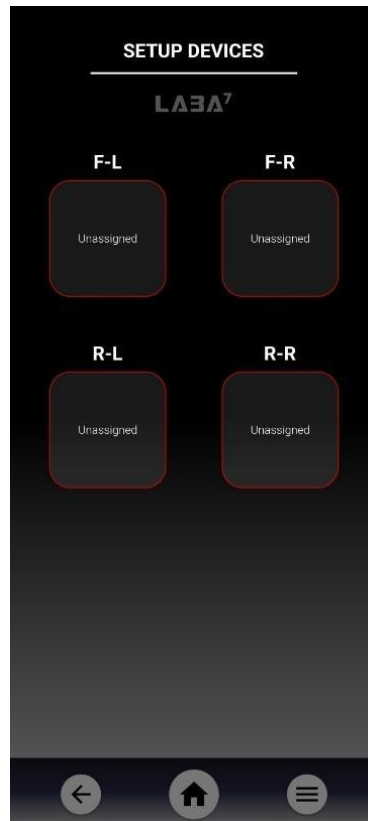



Fig. 6.

6. Press on RL, the list opens with all visible pads. Press on the corresponding scale pad name. After the Wi-Fi icon near the pad address turns green , it means it is successfully connected. Remember that this pad will always have to be under rear left wheel.
7. Do the same with every other pad.

9. Weighing a car

There are two types of weighing a car. Weighing just the total weight of the car, or weighing-out car corner weight.

9.1. Measuring total weight of the car - Bubble leveling

If the user needs to only measure the total weight of the car, he can choose between bubble leveling or laser leveling. Bubble leveling option uses 3 point leveling system which is achieved by the 3 leveling feet located on the sides of the scale pads. To level the scale pad using bubble, user has to complete following steps:

- Unscrew 2 side feet which are pointed with arrows in the picture below, to the point they are not touching the ground.

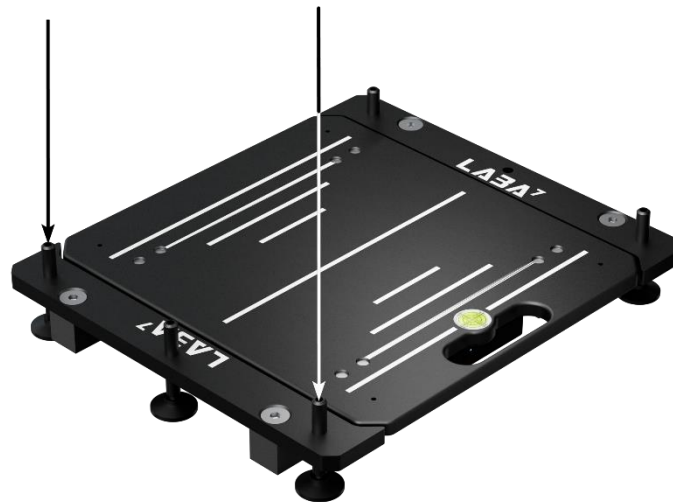

Fig. 7.

- Adjust the scale pad by turning 3 leveling feet pointed with arrows in the picture below with the allen key until the bubble settles in the middle.



Fig. 8.

- Turn the side leveling feet which was unscrewed before, hand tight, to the point it touches the ground.
- Unscrew the middle foot which was used for leveling to the point it is not touching the ground.

9.2. Weighing out corner weight - Laser leveling

If the user needs to scale out car corners, he must use laser leveling. To level the scale pads with the laser, user has to complete following steps:

- Slide the pads under the wheels. The center of the wheel must be as close as possible to the center of the scale pad.
- Put the leveling figures on the scale pads as shown in picture below.

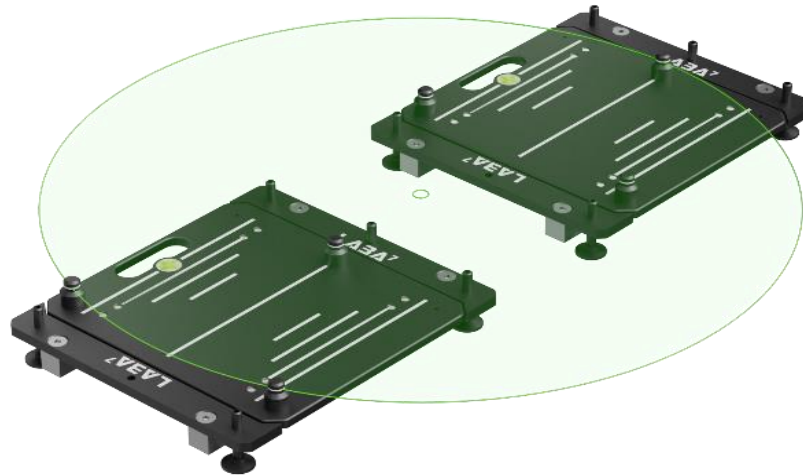

Fig. 9.

- Put the laser in front of the car. Adjust it to the point that the laser is pointing at the upper part of the leveling figures, as shown in the picture above.
- Adjust the pad so the laser points to the same spot on every leveling pin. Adjusting is done by turning 3 leveling feet with an allen key. While doing this step, on one side of the pad only middle foot is used, so unscrew the side ones to the point they are not touching the ground. Which feet to unscrew is shown in Fig. 7.
- After leveling is done, turn those unscrewed feet, located on the sides of the pad(Shown in Fig.7) hand tight, until it touches the ground and unscrew the middle one, which was used for leveling, to the point it will not touch the ground.
- Do the same for every pad



ATTENTION: Laser leveling is necessary to correctly scale out the car corner weight.

9.3. Measuring distances between wheels and axles

If the user needs to measure the mass center of the car, he has to measure distances between front and rear axles and the distance between left and right wheel (rear and back, on some cars it differs).

The axle distance measurements are done by measuring the distance between front and rear differentials.

Wheel distance measurements are done by measuring distance from the middle of the left wheel to the middle of the right wheel. Same for rear and front (Check the picture below).

Enter the measured values into the axles section in the app.

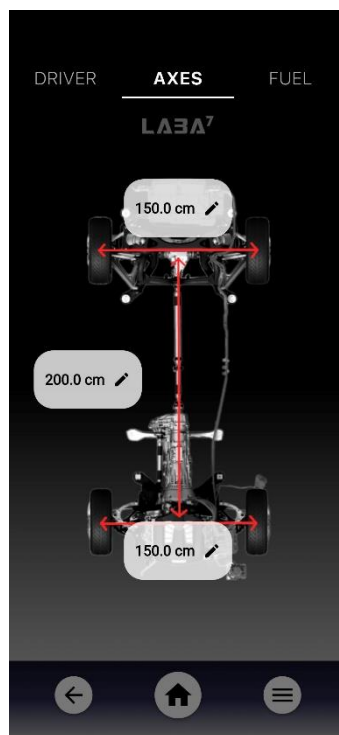

Fig. 10.

9.4. Putting the car onto the scales

To put the car onto the scale pads, the car needs to be lifted, and the pads needs to be slid under the wheels. Then, the car must be slowly lowered onto the pads. The car can be lifted by lifting all wheels together at a time, or every wheel one by one. Also, front and back of the car can be lifted separately.

10. LABA7 Scale Software

All the control and output of the scales works via LABA7 car scales app on your phone.



Fig. 11.

- Tap and swipe to move through the app.
- App has visual and text output modes.
- App works with Android and iOS platforms.

- Every pad shows its battery status in the app.
- App shows measurements like diagonal weight, mass offset.

10.1. Visual and text modes in the app

The app is able to represent the data in two forms: Visual and Text. To switch between the modes, swipe left/right.



Fig. 12.

10.2. Setup devices

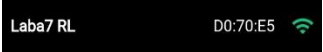





1. In the app, go to settings menu -> setup devices.
2. Every wheel has its own pad: FL, FR, RL, RR.
3. Press on RL, the list opens with all visible LABA7 pads. Press on the corresponding one. After the Wi-Fi icon near the pads address turns green , it means it is successfully connected. Remember that this pad will always have to be under rear left wheel.
4. Do the same with every other pad.

Bluetooth loading time can take up to 10s.



10.3. Car setup

To get the most of the LABA7 car scales and its app, user can enter parameters of his sports car like: Fuel weight, fuel tank position on the car, distances between axles, driver's weight and his seat position in the car. To do this, press  button in the bottom of the app.

After entering car setup screen, in the top part of the screen user can choose which parameter user wants to enter-driver, axes and fuel.

- After selecting driver parameters press on driver's weight  and enter the weight of the driver. Then, the user has to enter the driver's seat position distance from the front left axle. Take measurements and enter them into the app by pressing on  Do this for both distances-vertical and horizontal.
- After selecting axes parameters, user has to measure distances from left to right wheels and from front and rear wheels. The measurement has to be taken from the middle of the wheel. In the app there is a visual instruction from which points to measure. After measurements are taken, press  and enter the distances.
- After selecting the fuel parameters, the user has to enter the fuel tank volume into the app by pressing  After the tank volume is entered, user has to take measurements of the distance from the rear right wheel to the center of the fuel tank. After the measurements are done, enter them into the app by pressing  The user has to enter the fuel density in options as well, please see section 10.6.
- To enable or disable the fuel and driver weight in the measurements, click on checkboxes  and 

10.4. Navigation

- Press  to get back to the home screen.
- Press  to get back to the previous screen.
- To open the settings menu, press  in the lower right corner of the app.

10.5. Tare

After opening tare settings, all 4 of the pads and weight on them is shown. If there is no weight on them, but the app does not show 0kg, press  button in the middle bottom of the app. If all 4 of the pad values went to 0, press  .

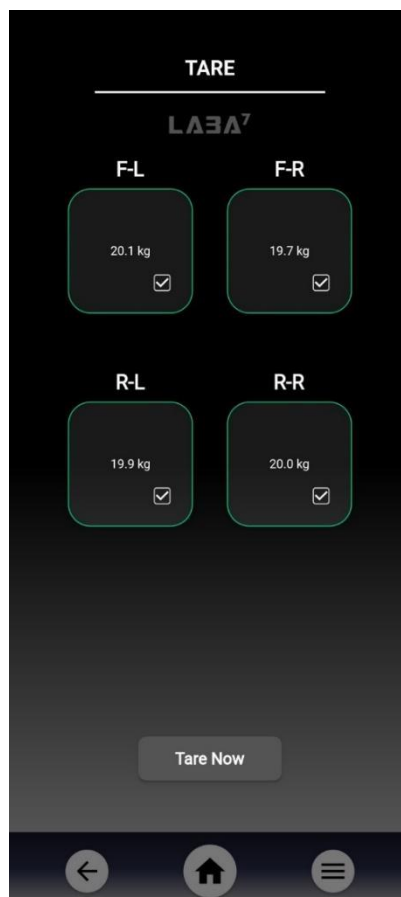





Fig. 14.



Each scale can be tarred individually. Click on the corresponding checkbox in order to select or deselect the scale to be tarred.

10.6. Options

The user can select the desired unit system- metric or imperial. To do this, user has to go to the options section, which is located in the menu. Press options, then press on the  and select between metric and imperial systems. Also, the user is allowed to change the car picture in the main screen. To do this, in options menu, press  and select the image of your car. We strongly recommend to use 327x652 PNG image with transparent background. If the user uses fuel volume in his car scaling, he has to enter the fuel density. To do this, press on  and enter the density of the fuel.

10.7. Calibration

For the best accuracy over time, the user is allowed to calibrate the scales by himself. To do it, some object with exact known weight is needed (more than 20kg). This feature is for experienced users only, the user takes the responsibility for proper calibration of the scales.

1. In settings menu, press calibration. The warning message will pop up. If the user wants to proceed further, press **continue**.
2. Press on the desired pad.
3. Press .
4. Put the object on the pad with the exact known weight.
5. Enter this weight in the app.
6. Press .
7. Do the same with every other pad.

10.8. Reports

The app is able to save reports of every car user has done measurements with. To do this, press  which is in the lower left side of the app. Enter the name and comment (if needed), and press save. The reports can be found in the settings, saved reports.

The app has the ability to store reports from previous tests. How to save reports is shown in the paragraph 7.2. All the saved reports will be found here, in the settings, saved reports.

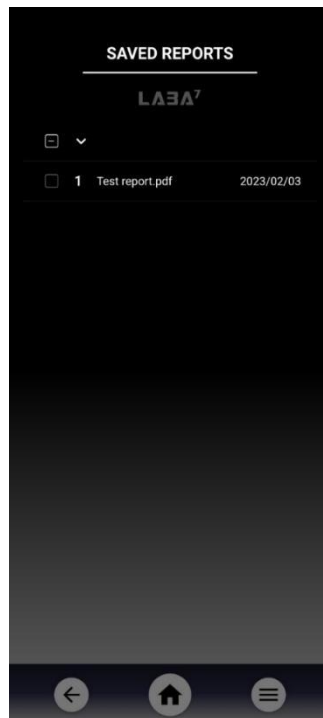



Fig. 15.

The app gives the user possibility to share and delete saved reports. To do this, go to saved reports; after selecting one or more reports, share  and delete  icons appear.



10.9. Calculations and measurements



Fig. 16.

LABA7 scale app is able to represent measurements received from the pads. Front – represents how much weight is on front axle; it sums up FR and FL weights. Also, the percentage is shown, how much weight is on the front axle and how much weight is on the rear axle.

- 1. Rear – represents how much weight is on the rear axle; it sums up RR and RL weights.
- 2. Left – represents how much weight is on the left side of the car; it sums up FL and RL weights. Also, the percentage is calculated, how much weight is on the left side of the car and how much weight is on the right side of the car.

3. Right – represents how much weight is on the rear side of the car; it sums up FR and RR weights.
4. FLRR represents how much weight is on the Front left and Rear right diagonal. It shows weight in kilos, which is FL and RR weights summed up and also calculates the percentage how weight is split between diagonals.
5. FRRL represents how much weight is on the front right, and rear left diagonal.
6. F-L represents how much weight is on the front left wheel.
7. F-R represents how much weight is on the front right wheel.
8. R-R represents how much weight is on the rear right wheel.
9. R-L represents how much weight is on rear left wheel.
10. Total weight represents the total weight of the car. It is RR FR FL RL weights summed up.
11. Axis length: front represents the distance between the middles of left and right wheels in the front.
12. Axis length: rear represents distance between the middles of left and right wheels in the rear.
13. Between axis represents distance between front and rear axles.
14. Mass offset  represents how much the mass center deviates from the center of the car in the vertical axis.
15. Mass offset  represents how much the mass center deviates from the center of the car in horizontal axis.
16. Dry weight: the weight of the car without fuel and driver
17. Fuel weight: the weight of the fuel, which is defined by the fuel tank volume and the fuel density

11. Troubleshooting

11.1. Possible problems and solutions

Problem	Possible solution
App does not see one or more of the pads.	Go to the settings, setup devices, check if all 4 of the pads are linked and lights in green color. MAC address of each pad should be shown.
App does not see any of the pads.	Check if the Bluetooth is enabled on the phone.
Some of the pads does not connect to the app.	Check if the batteries are ok.
The pad does not turn on.	Check if the batteries are full and if they are installed correctly.
App does not see one or more of the pads.	Check if the pads are active. Blue light should be flashing
Some of the pads is not seen during device setup.	Check if the pads are active. If not, press the white button. Blue light flashing indicates that the pad is on.
App does not connect to one or more pads, although they are visible.	Restart the app and the scales pads.
App does not connect to any of the pads.	Check if location services on the phone are turned on.

11.2. Malfunctions

Malfunction	Possible solution
Although no weight is put onto the pad, the app shows some weight on it.	Go to the settings, tare. Press tare Now.
After zero tare, the app still does not show 0s on the pads.	Go to the settings, calibrate and complete steps from paragraph 7.9.
App shows incorrect weight on the pad.	Go to the settings, calibrate and complete steps from paragraph 7.9.
The weight values on the app are stuck at some specific value.	Restart the app and scales.
After zero tare, the app still does not show 0s on the pad.	Check if the pad is powered on.

12. Maintenance

Changing the batteries

When the voltage of the batteries is getting low, the user gets a notification  about low battery in the app near the scale pad, indicating which battery is getting low. The battery compartment placement is shown in paragraph 5.1 (nr. 5). Unscrew 2 screws holding the battery compartment lid, open it. Install the batteries by following polarity instructions printed on the battery compartment, put the lid back again.

Changing the sliding pad oil

If the user uses the sliding pad accessory, regular change of the oil is needed. How often the user must change oil depends on the environment he is working in. The amount of dust and dirt affects how frequently the user must change the oil. The oil has to be fresh, without dust and dirt, so the pad can slide smoothly and do not cause any scratches to the scaling pads.

Cleaning the threads of leveling feet

Once in a while, LABA7 recommends cleaning the threads of the leveling bolts from dirt and dust, so the bolts will turn smoothly, and the threads itself will not get damaged. To do this, simply unscrew them and clean with wipe or blow the dust and dirt with compressed air.

13. Warranty information

LABA7 car scales are covered for 1 year of manufacturer warranty starting from the date of purchase and it covers any manufacturer-related failures during that period.

WHAT IS NOT COVERED

ALTERATION, MISUSE, OR ACCIDENT DAMAGE

Examples are:

- Failure to operate the device in accordance with the Owner's manual.
- Collision, fire, theft, freezing, vandalism, riot, explosion, or objects striking your Scales.
- Alteration of your scales, including software programming or other components.
- Damage caused by improper maintenance or failure to follow the recommended maintenance schedule.

The repair of damages that are caused because parts or services used were not those prescribed in this manual's recommended maintenance schedule is not covered under warranty. It is the owner's responsibility to maintain the scales as more fully set forth in and in accordance with the maintenance schedules outlined in this manual.

MODIFICATIONS

Damage or performance problems resulting from modifications to your scales are not covered under warranty.

Examples of modifications:

- Altering any mechanical parts or software programming.

The manufacturer is not responsible for any damages to the device during the transportation. During accepting the shipment, please inspect the package for any visual damage. If the package is damaged, do not accept it.

14. Contact

If you have further questions about the product or need help with the installation, our technical staff will be happy to help you. Contact information can be found on our website www.laba7.com.

- UAB LABA7

- Giluzio g.15
Vilnius
LT-08412
Lithuania

- info@laba7.com
- +37062199469

Reprinting, even in extract, is allowed only after obtaining approval. We reserve the right to make changes to the product at any time, if we consider them to be in the interest of quality improvement without prior notice or notification. Figures may be examples which may differ in appearance from the goods delivered. We also reserve the right to errors and cannot be held responsible for typographical mistakes. Our general terms and conditions apply.